

MOTOR SPECIFICATION SHEET

MODEL : SF-JRFB 2HP 6P (LT)

USED FOR : BRAKE MOTOR

DESCRIPTION	DETAIL					
PHASE	3					
MODEL NAME	SF-JRFB					
RATED OUTPUT, HP (kW)	2 (1.5)					
POLE	6					
CODE						
OUTLINE DRAWING NO.	OMM04O110-A					
RATED VOLTAGE (V)	220	380	415	220	440	
RATED FREQUENCY (Hz)	50	50	50	60	60	
RATED CURRENT (A)	7.0	4.0	4.0	6.6	3.6	
RATED SPEED (min ⁻¹)	930	930	940	1110	1120	
THERMAL CLASS	155(F)					
RATING	S1 (CONTINUOUS)					
ENCLOSURE CONSTRUCTION	TOTALLY ENCLOSED FAN COOLED					
DEGREES OF PROTECTION	IP55					
METHOD OF COOLING	IC411					
FRAME NO.	100L					
WEIGHT (kg)	37					
STANDARD	IEC 60034-1, JEC-2137-2000					
INSTALLATION	FLANGE MOUNTED (HORIZONTAL)					
ROTATION	CCW (VIEWED FROM SHAFT END)					
BEARING	LOAD SIDE : 6206ZZ					
	OPPOSITE SIDE : 6205ZZ					
BEARING GREASE	UREA GREASE					
NOISE (db.A)	61 (RUNNING OPERATION)					
VIBRATION	V30					
CIRCUMSTANCE CONDITION	AMBIENT TEMPERATURE : -20 ~ +40°C					
	AMBIENT HUMIDITY : 95%RH OR LESS					
	ABOVE SEA LEVEL : 1000m OR LESS					
	ENVIRONMENT : NO BURSTING/EROSIVE GAS OR VAPOR					
COLOR	MUNSELL N5.5 (GRAY)					
TERMINAL BOX	NO. OF LEAD WIRES : 6					
	SOURCE CONNECTION : TERMINAL BLOCK					
INSULATION RESISTANCE	BY DC 500V MEGGER - ≥100MΩ					
DIELECTRIC TEST	AC 50Hz 1800V - 1min. (Based on rated voltage 380V)					
SHAFT SWING	≤0.03mm					
MATERIAL	FRAME : STEEL PLATE					
	BRACKET LOAD SIDE : CAST IRON					
	OPPOSITE SIDE : CAST IRON					
	SHAFT : CARBON STEEL					
	STATOR CORE : ELECTRICAL STEEL					
	WIRE : ENAMELLED COPPER MAGNET WIRE					
	INSULATOR : POLYESTER FILM SATURATED WITH RESIN					
	VARNISH : EPOXY DENATURALIZATION POLYESTER					
	ROTOR CORE : ELECTRICAL STEEL					
	CONDUCTOR : ALUMINIUM					
	TERMINAL BOX : STEEL PLATE					
	PAINTING : POLYURETHANE RESIN					
	BRAKE	TYPE : TB-A2.2 (DC)				
RATED BRAKING TORQUE : 22 N.m						
ELECTROMAGNETIC STROKE : INITIAL = 0.2 mm., ADJUSTABLE LIMIT = 0.5 mm.						
PRODUCTION COUNTRY	THAILAND					

Specifications subject to change without notice.

SPECIFICATION SHEET NO.				
SS-M-0338-A				

MODEL SF-JRFB THREE PHASE INDUCTION MOTOR OUTLINE DRAWING

TOTALLY ENCLOSED FAN COOLED
 DEGREES OF PROTECTION IP55
 DUST & WATER JET PROOF
 FLANGE TYPE BRAKE MOTOR

CUSTOMER _____
 USER _____
 FOR _____
 CUSTOMER'S ORDER NO. _____
 QUANTITY _____
 MFG. ORDER NO. _____

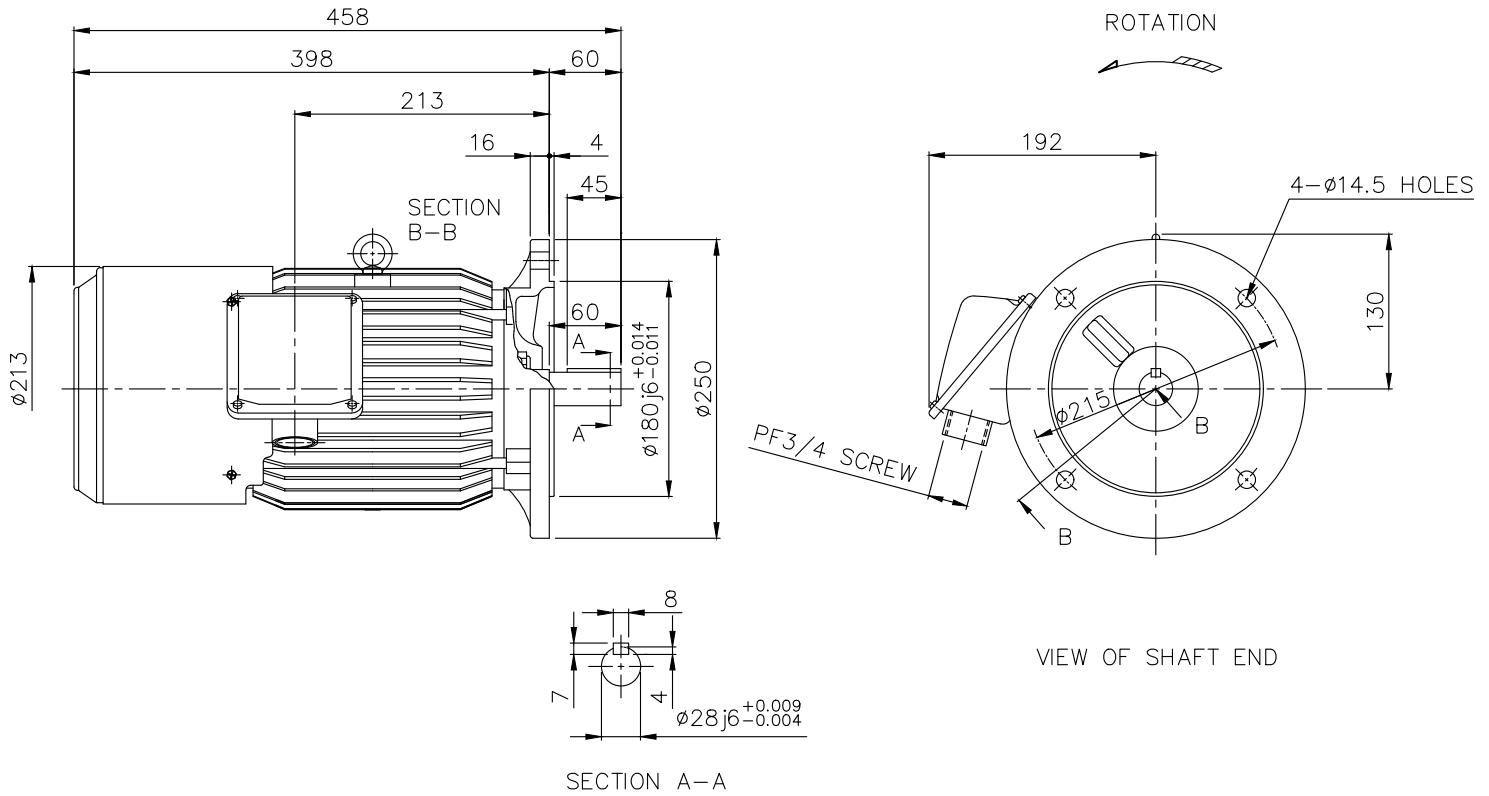

BRAKE TYPE	RATED DAMPING TORQUE(N.m)	ELECTROMAGNETIC STROKE(mm.)	
		INITIAL	ADJUSTABLE LIMIT
TB-A2.2	22	0.2	0.5

YOUR ORDER	FRAME SIZE	RATING	TH. CLASS	AMB. TEMP.	BEARINGS		COLOR	DIRECTION OF ROTATION (VIEWED FROM SHAFT END)	NO. OF LEAD WIRES	REMARKS
					LOAD SIDE	OPP. SIDE				
	100L	S1 (CONT.)	155(F)	40°C	6206ZZ	6205ZZ	GRAY (MUNSELL N5.5)	CCW	6	

YOUR ORDER	OUTPUT		POLES	VOLT	HERTZ	REMARKS
	HP	kW				
	3	2.2	4	220/380/415	50	LT
				220/440	60	
	2	1.5	6	220/380/415	50	LT
				220/440	60	

MITSUBISHI ELECTRIC AUTOMATION (THAILAND) CO., LTD.

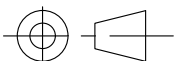

DIMENSION IN mm.

SCALE : NTS

OUTLINE DRAWING NO.

0 M M 0 4 0 1 1 0

REV.

A